

SARAYA Alcohol Toilet Seat Sanitizer

Instruction Manual

SC-450

Thank you for your interest and purchase of the Alcohol Toilet Seat Sanitizer Dispenser. You are urged to thoroughly read this instruction manual before operating the dispenser. Keep this instruction manual handy for future reference.

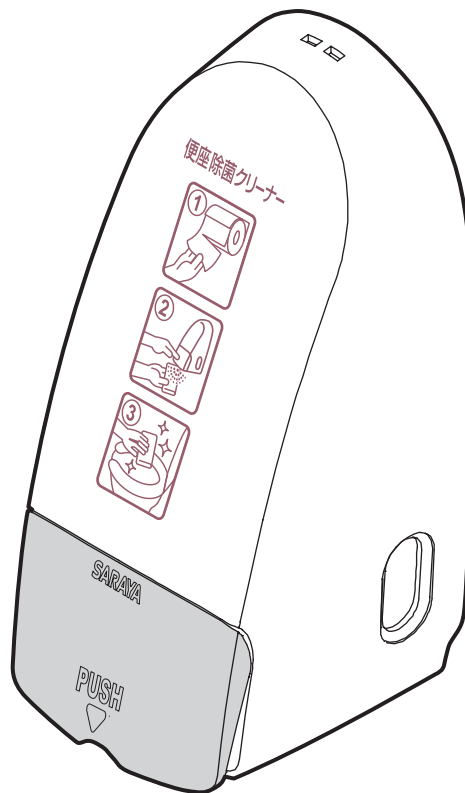

SARAYA

Contents

Safety Precautions	3
Installation	
Use	
Relocation and Repair	
Principal Parts	5
Installation	6
Installation Location Selection	
Installation procedure	
How to use	7
Opening / Closing the cover	
Refill the alcohol sanitizer	
How to use	
Precautions in using	10
Cleaning the nozzle	
Before calling for repair	10
Specifications	11

Accessories

- Alcohol sheet (1)
- Key (2)
- Instruction manual (1)

Safety Precautions



In order to safely and properly use the unit, you are urged to thoroughly read these "Safety Precautions" before using the unit. The precautions stated in this manual describe important safety information and you are advised to abide by them. After reading, keep this manual readily available for future reference.

Installation

DANGER

-  Do not install near open flames.
Do not install near anything that generates sparks.
A fire may be caused.

WARNING



-  Install indoors where the unit is not exposed to direct sunshine. Do not install where the temperature may become high.
A fire may be caused.
-  Securely mount the unit to a sturdy area of the wall. Do not mount the unit onto coated surfaces with double face tape.
Failures may be caused due to the unit falling.

Use

WARNING

-  Do not directly pour or splash water over the main body.
Malfunctions may be caused.
-  Never drink the liquid soap or the sanitizer.
Doing so would be harmful to your health.

CAUTION

-  Sufficiently ventilate when alcohol sanitizer is used. Use the alcohol sanitizer in the place where good ventilation is available.
If ventilation is poor, the area is filled with alcohol gas that may ignite. You may feel ill.
-  Do not use sanitizer other than this specified by us.
Failures may be caused.
-  Keep hands wet with alcohol sanitizer away from flames.
If the alcohol gas ignites, it could cause burns and fires.

Use (continued)

CAUTION

 Take care not to inhale the sprayed alcohol sanitizer.

The alcohol gas irritates the nose and throat mucous membranes.

 Do not place anything on the unit.

It may fall.

 Before handling the sanitizer, thoroughly read the Instruction Manual of the chemical.

 Before installing and opening/closing the cover, thoroughly read the precautions and instructions.

 Take care in refilling the sanitizer not to spill the liquid. Any spills should be wiped away immediately.



 When the unit is not used for a long time or when it is stored, be sure to wipe the main body and empty out the sanitizer bottle.

Relocation and Repair



WARNING

 No one other than repair engineers should attempt to disassemble, repair, or modify the unit.

Please note the following definitions:

 DANGER	A critical hazard that could result in death or serious injury due to improper operation.
 WARNING	A hazard which may possibly result in injury or death due to improper operation.
 CAUTION	A hazard which may result in complications or conditions possibly resulting in personal or material damage.

Symbol legend

 Never attempt this.
 Be sure to follow instructions.
 Never attempt to disassemble, repair, or modify.

Principal Parts

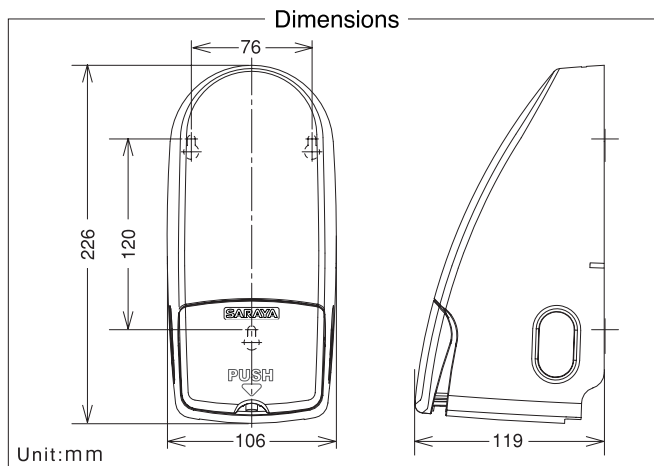
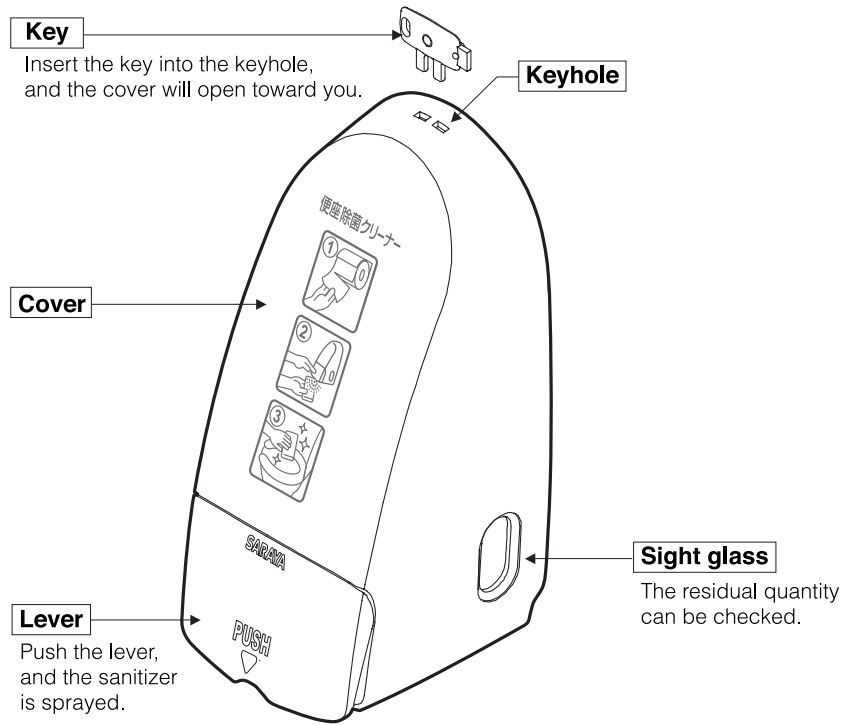

Installation

Installation Location Selection

Install the unit on a rigid wall.

Before installing the unit onto a weak wall (6mm or less construction panel or plasterboards, etc.), the wall surface should be reinforced. Installation on a weak wall may cause failures due to falling.

Install the unit in an area free from heat and freeze.

Avoid exposure to direct sunlight and keep away from heat sources such as cooking apparatus and heating apparatus, or the thermal influence may cause fire.

Keep away from open flames.

Avoid installing the unit near any apparatus generating fire or sparks.

Keep away from moisture.

Moisture or water spray may result in rusting and malfunction.

Installation procedure

- Put double face tape of the backside of the body to mount. Wipe away dust, dirt, oils and greased from the surface of the wall with the alcohol sheet (accessories). Dry it for 10 minutes or more. Peel the protection paper from the double face tape and press the body with the tape onto the wall for 10 seconds or more to fix.

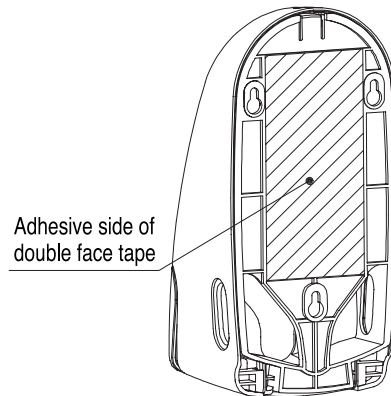

Note

1. The double face tape must not be used to mount the unit onto a wall with a coated surface or wallpaper.
2. The double face tape cannot adhere to a wall with an uneven or rough surface.

Note

The distance between the unit top and the ceiling must be 10cm or more in order to use the key and open the unit.

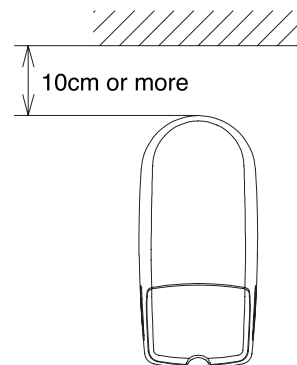

Installation

Installation procedure (continued)

- When it is a problem to install with the double face tape, use 3 holes of the holder and fix with screws.

Note

The screws is not included and prepare for them. Choose and use screw type in accordance with the material of the mount to be fixed.

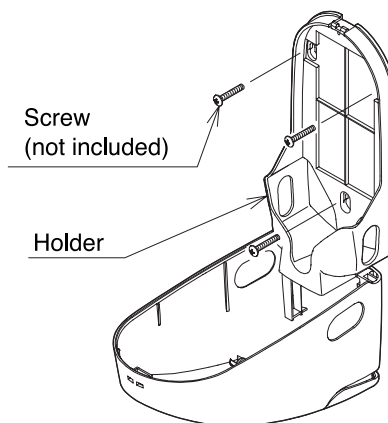

How to use

Opening / Closing the cover

Put the key into the keyhole on top of the unit. While holding the cover, open it toward you. Return the cover to its original position. Press it until it snaps into place.

Note

1. The cover must be opened toward you while holding.
2. Take care to prevent your fingers from being caught or the cover from being damaged.
3. Make sure not to lose the key.

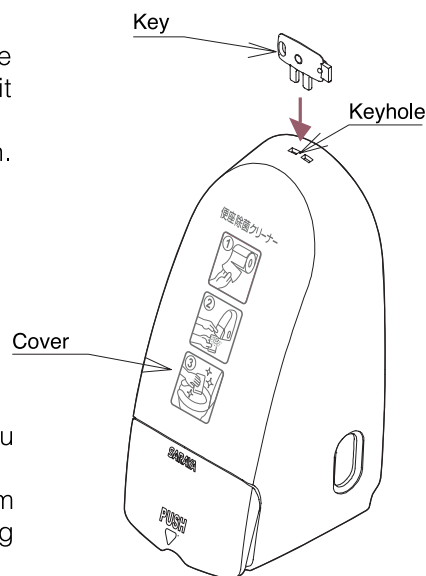

How to use

Refill the sanitizer

- ① Open the cover take out a bottle.

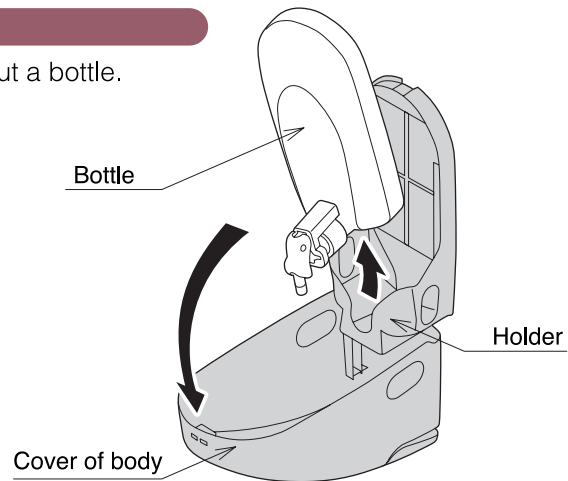

- ② Remove the pump from the bottle and refill specified alcohol sanitizer.

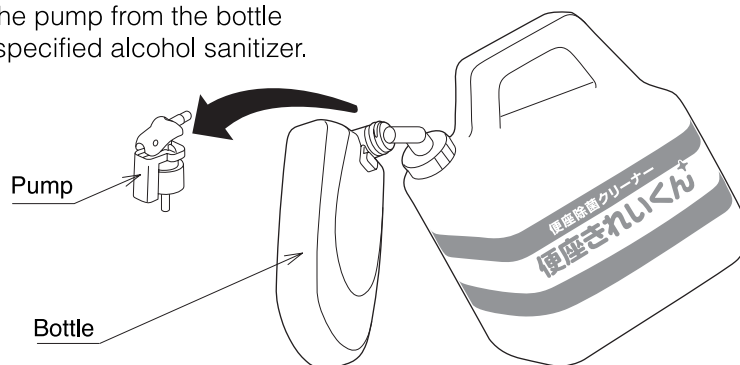

- ③ Set the pump to the bottle. Fit positioning cover of the pump to bottle protrusion part and tighten the pump.

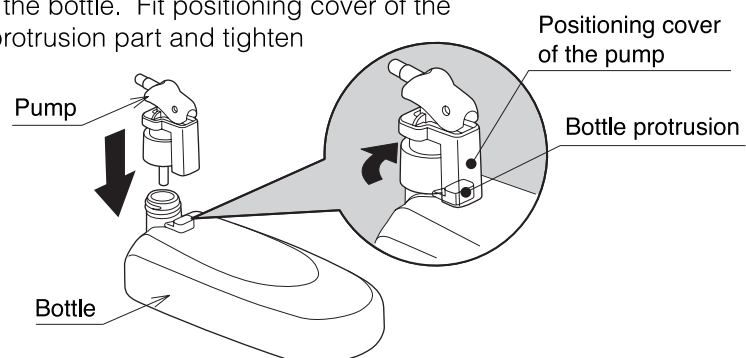

How to use

- ④ Set the bottle to the holder and close the cover.

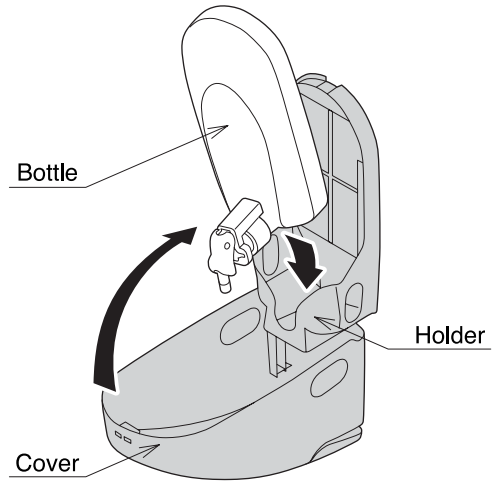

How to use

Press the lever and the sanitizer will be sprayed.

Note

1. Just after the bottle is set, not liquid may be sprayed from the nozzle immediately even if the lever is pressed. Repeat to press the lever until the liquid is sprayed.
2. Do not press the lever violently. Pressing too strongly may cause failures.
3. Before using, thoroughly read the "Precautions in using" attached on the liquid products.
4. Immediately wipe off any spill of liquid on the floor; or falling, injuries, or other hazards may be caused.

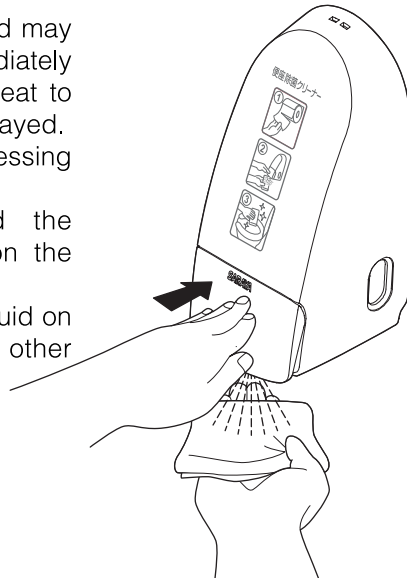

Maintenance

To make the unit stand long use, carry out periodic maintenance tasks. Wipe off dirt with dry soft cloth. Very dirty portions should be wiped with cloth soaked in properly diluted neutral detergent solution. Soak soft cloth in water, squeeze it dry, wipe off the detergent, and finally wipe the portions with dry soft cloth.

Note Do not use the following.

Thinner, benzene, alcohol, petroleum, powder soap, polishing powder, detergent other than neutral detergent, boiling water, acids, alkaline materials, scrubbing brushes, etc.

When chemical cloth is used, observe the directions.

Cleaning the nozzle

The nozzle clogged with liquid or dust may cause incorrect spraying and malfunction. In this case, take out the nozzle and soak only the nozzle end in hot water (approx. 70-80°C) for approx. 2 minutes.

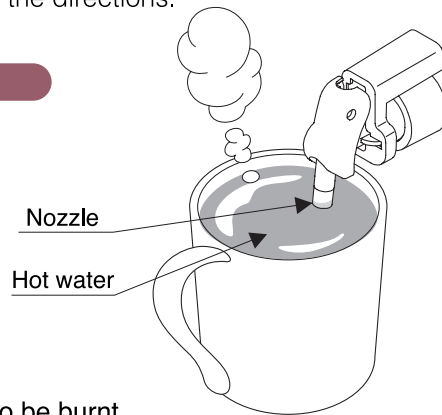

注意

1. In handling hot water, take care not to be burnt.

※ Unless the nozzle sprays correctly after the check, ask Saraya sales representative.

Before calling for repair

First, investigate the following when " failure " is suspected.

Problem	Check point	Page
Liquid is not sprayed.	<ul style="list-style-type: none">● Check if the liquid runs out.● Check if the nozzle is clogged.	8 10

Investigate the above points. If the unit does not operate satisfactorily, immediately contact Saraya sales representative without repairing for yourself.

Specifications

Item	Details
Name	Alcohol sanitizer dispenser
Model	SC-450
Dimensions (mm)	W106×D119×H226
Weight	Approx 370g (excluding package, accessories, and liquid)
Material	Cover ABS Holder ABS Lever POM Pump PP Bottle HDPE
Dispenser rate	Approx. 0.3mL per dispenser
Capacity	Cartridge type 450mL
Dispensing solutions	Benza Kireikun

The specifications are subject to change without prior notice for improvement.