

TORK®**Xpressnap®
Stand
Napkin Dispenser****N4**Signature
Design

Loading Instructions Instrucciones de Recarga Instructions de Remplissage

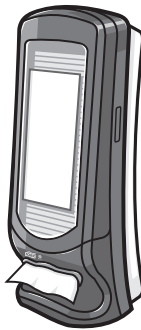

AD-a-Glance® Feature Espacio Publicitario Para AD-a-Glance Fonction AD-a-Glance

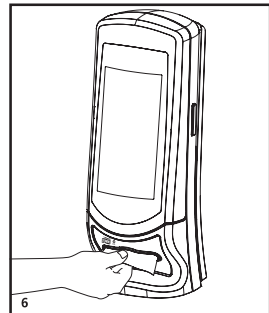
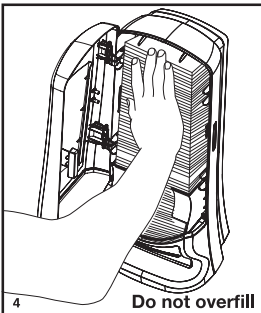
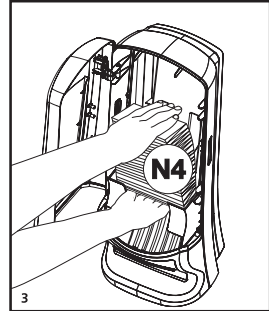
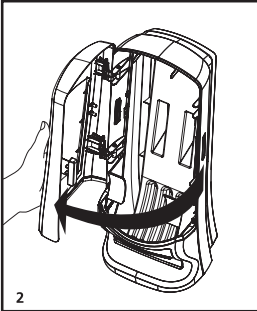
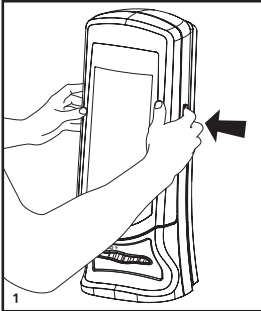
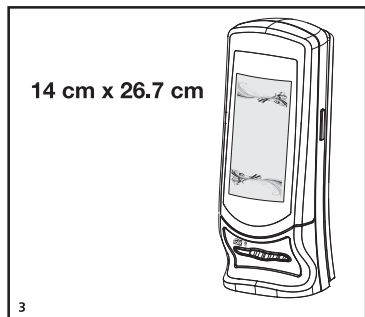
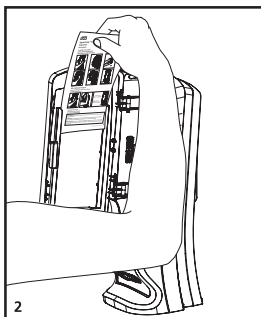
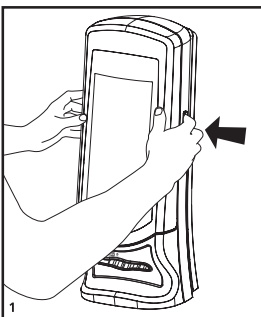

Cleaning Instructions Instrucciones de Limpieza Instructions de Nettoyage

TEMPLATES @
<http://adaglance.sca-tork.com/>

CLEANING: Use mild cleaners. Wipe with cloth using soap and water. Do not use abrasives. Dispenser is not dishwasher safe.

LIMPIEZA: Utilice limpiadores suaves. Frote con un paño humedecido con agua y jabón. ¡No use abrasivos! Es dispensador no se debe lavar en máquinas lavavajillas.

NETTOYAGE: Utiliser des nettoyeurs non agressifs. Nettoyer avec chiffon, de l'eau et du savon. Ne pas utiliser d'agents abrasifs. Le distributeur n'est pas conçu pour être nettoyé au lave-vaisselle.

Manufactured by SCA,
SE-405 03 Göteborg, Sweden
www.sca-tork.com
Made in United States

